

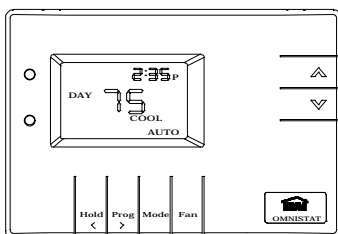

OMNISTAT

ELECTRONIC COMMUNICATING THERMOSTAT



Owner's Manual

RC-101 Heat Pump Real Time Pricing System 2 Stage Heat / 1 Stage Cool

Document Number 13R00-4
January, 1997

**Copyright © 1997 Home Automation, Inc.
All Rights Reserved**

CONTENTS

INTRODUCTION	1
DESCRIPTION	1
ABOUT HEAT PUMPS	2
OPERATION	4
DISPLAY	7
FILTER REMINDER	9
ANTICIPATION	9
REAL TIME PRICING SYSTEM	10
SETTING THE CURRENT TIME AND DAY	11
PROGRAMMING	12
SETTING THE VARIATION FOR HIGHER RATES	12
SETTING TIME SCHEDULES	13
SYSTEM MODE	14
AUTOMATIC TIME UPDATE	15



This thermostat is Listed by Underwriter's Laboratories and UL Canada.



This thermostat has been tested and found to comply with the requirements of the European Union for Electromagnetic Interference, Electromagnetic Immunity and Safety under the applicable EMI and Low Voltage Directives and Standards.



This thermostat has been tested and found to comply with the limits for a Class B digital device, pursuant to part 15 of the FCC Rules.

This product generates and can radiate radio frequency energy. Due to its low power design, it is unlikely to interfere with radio and TV communications. If it is suspected of doing so, the user is encouraged to try to correct the problem by reorienting the receiver's antenna, moving the receiver away from the product, or consulting an experienced radio/TV technician for help.

INTRODUCTION

Thank you for purchasing your new RC-101 heat pump electronic communicating thermostat. Your thermostat will provide you with comfort, convenience, and energy savings for years to come.

We hope that you take a few moments to become familiar with all of the features of this fine product by reviewing this manual. Please keep this manual on file for future reference.

DESCRIPTION

The RC-101 is a precision digital thermostat with Real Time Pricing, specifically designed for heat pumps. It has the capability of being controlled both locally and by remote control. It offers programmability, stand alone operation, and robust, optically isolated communications with automation systems, utility control systems, and personal computers.

There are several items which can be configured at the time of installation. These items have a check box () for your installer to indicate which features are used in your system.

As an EPA ENERGY STAR Partner, Home Automation, Inc. has determined that this thermostat meets the ENERGY STAR guidelines for energy efficiency.



MAINTENANCE

Your new thermostat is maintenance free. There is no battery to install or replace. If necessary, clean unit carefully with a mild soap solution on a soft cloth.

ABOUT HEAT PUMPS...

A heat pump is a mechanical refrigeration system that operates in two modes, heating and cooling. In cooling mode, the heat pump takes indoor heat and pumps it outside, just like a standard air conditioner. In heating mode, the process is reversed: the heat pump takes outside heat and pumps it inside. Although it feels cold outside, the air still has heat in it that the heat pump can use as a source of heat. The fact that the heat pump *moves* heat from one place to the other (as opposed to *creating* heat directly from electricity or gas) is the key to its remarkable efficiency. A heat pump usually produces *over 3 times* more heat per watt of electricity than standard electric heating.

While some heat pumps use outside air as their source of heat, others use the heat available under the ground or in a water well. These are called air-source, ground-source, or water-source heat pumps, respectively. The RC-101 is capable of controlling all of these types of heat pumps.

In extremely cold conditions, the heat pump may require assistance from another source of heat, known as "auxiliary heating". Auxiliary heating is less efficient than the heat pump, so it is best to use the heat pump instead of the auxiliary heat.

For normal and most efficient operation, the RC-101 should be in HEAT or AUTO mode so that it can properly control the auxiliary heat. The heat pump is used first, auxiliary heat is used only if necessary.

In EMERGENCY HEAT mode, the RC-101 will turn the heat pump off and use the auxiliary heating only. This mode may be used if the heat pump has failed.

ENERGY EFFICIENT CONTROL

Using the programmable or remote control features of your thermostat, you can save energy costs by setting back the thermostat during unoccupied times. This reduces the energy loss from indoors to outdoors. In the past, it has been said that heat pumps should not be set back because it takes more energy to re-heat the premises than to keep it at the same temperature. This is true with mechanical thermostats, because they will use the inefficient auxiliary heat to recover from the setback. This is not true with the RC-101, because it uses intelligence to ensure that recovery from setback is done using the heat pump, and not the auxiliary heat. Because the heat pump takes longer to recover, heat pumps should not be set back for periods of time less than 4 to 6 hours.

The RC-101 has microprocessor intelligence that continually monitors the performance of the heat pump and uses the auxiliary heat only when necessary. If the RC-101 determines that the heat pump is able to heat at a rate of 5 degrees per hour or better, the auxiliary heat will not be used. If the heat pump is unable to heat at this rate, the RC-101 will use the auxiliary heat to supplement that of the heat pump. Under these conditions, the heat pump will run continuously and the auxiliary heat will cycle on and off as needed.

If you wish to temporarily override Energy Efficient Control to heat as quickly as possible, press the Hold key. The RC-101 will use the Auxiliary Heat as needed to reach the heat setting, then resume Energy Efficient Control once the setting is reached.

Remember to turn Hold off to resume programmed operation.

OPERATION

To take advantage of all the benefits and features offered by your thermostat, we recommend that you start by becoming familiar with its operation.

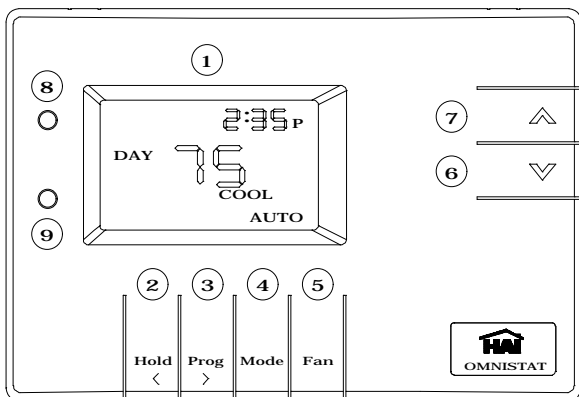

1- Display

The Display is used to show current time, temperature, outdoor temperature (optional), mode, and to give useful information that will guide you through normal operation of your thermostat.

2- Hold

Press the Hold key to set the system into Hold mode. In Hold mode, the thermostat will not change its settings by program.

When hold mode is first turned on, the RC-101 will use the auxiliary heat to get to the heat setting as quickly as possible. Once the temperature is at or very near the heat setting, or if the temperature is already near the heat setting, the RC-101 will resume energy efficient operation.

3- Prog

Press the Prog (programming) key to set the current time and day (hours, minutes, day of week), and to program the temperature time schedules for the MORN, DAY, EVE, and NITE periods.

4- Mode

Press the Mode key to set the thermostat mode to *Off*, *Heat*, *Cool*, *Auto*, or *EM Heat*.

In *Off* mode, the heating and cooling systems are both off and do not respond to changes in temperature settings.

In *Heat* mode, the heating system responds to maintain your desired heating setting.

In *Cool* mode, the cooling system responds to maintain your desired cooling setting.

In *Auto* mode, your thermostat will automatically switch between heat and cool to maintain your desired heating and cooling settings.

In *Emergency Heat* mode (displayed as EM HEAT) the thermostat will turn off the heat pump and use the auxiliary heating to maintain the temperature setting. This mode should only be used if the heat pump is malfunctioning, because the auxiliary heat costs more to operate than the heat pump.

5- Fan

Press the Fan key to set the system fan to *Fan Auto* or *Fan On*.

In *Fan Auto* mode, the fan runs only when the system calls for heating or cooling.

In *Fan On* mode, the fan runs continuously.

6- Down Arrow (▼)

Press the Down Arrow key to lower the desired temperature.

7- Up Arrow (▲)

Press the Up Arrow key to raise the desired temperature.

8- Aux Heat Indicator

The *Aux Heat* indicator (green) glows when the auxiliary heat is on.

9- Check Indicator

The *Check* indicator (red) may be used to indicate a malfunction of the heat pump, or for some other condition. Your installer will explain its use.

Note: To check your desired setting without changing it, press the up or down arrow key (▲ or ▼) once.

DISPLAY

The following icons will be displayed during normal operation:

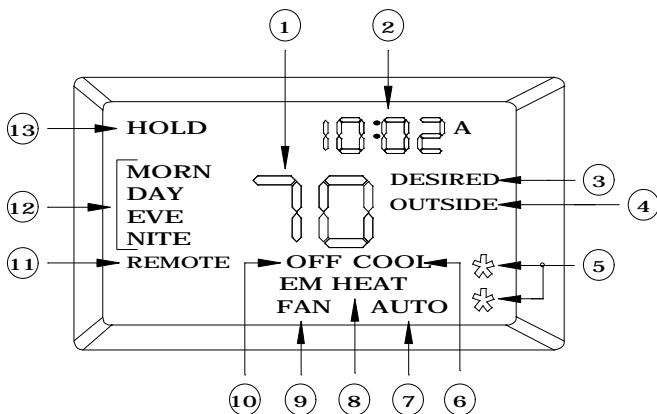

1- Temperature Display

Shows the current temperature, desired temperature, or heating and cooling settings.

2- Time Display

Shows the current time of day.

3- DESIRED

DESIRED is displayed when the temperature display shows the desired temperature setting.

4- OUTSIDE

- OUTSIDE will be displayed when the temperature display shows the outdoor temperature. The outdoor temperature will be displayed every 4 seconds.

5- ★

The *Top* ★ is displayed when the heating or cooling system is running.

The *Bottom* ★ is displayed when the Auxiliary heat is on.

6- COOL

COOL is displayed when the system is in Cool mode.

7- AUTO

AUTO is displayed when in automatic changeover mode.

8- HEAT

HEAT is displayed when the system is in Heat mode.

EM HEAT is displayed when the Emergency Heat is on.

9- FAN

FAN is displayed when the fan is set to run continuously.

10- OFF

OFF is displayed when the system is in the Off mode.

11- REMOTE

- REMOTE is displayed when the last command received by the thermostat was sent by a remote system.

12- Period Indicators

- MORN, DAY, EVE, or NITE is displayed when scheduled temperature changes are made by the thermostat programs.

13- HOLD

HOLD is displayed when the system is in Hold mode.

FILTER REMINDER

Your thermostat logs the amount of time your heating and cooling system has been running and gives you a reminder when it's time to replace your filter.

" F I L T " will be displayed every four seconds in the place of the time display when it is time to change you filter. To clear the reminder, press the Prog key. The display will return to normal in 10 seconds. Don't forget to change your filter!

ANTICIPATION

Your thermostat has a sophisticated control system designed to keep you comfortable while saving energy. Part of the control system is a feature called "anticipation", which anticipates the need to turn the system on or off before the temperature is actually at the setting.

As humans, we perceive temperature as a combination of heat in the air and heat radiated from the walls and surroundings. The thermostat also measures a combination of air and wall temperature. When heating, the air temperature rises faster than the wall temperature. The thermostat will turn the heat off briefly to prevent overheating the air while the wall temperature catches up. Your comfort is assured without overshooting the heat setting, which wastes energy.

In summer, the thermostat will periodically run the cooling system to circulate the air and remove humidity when the temperature is close, but not above the cool setting. You will be more comfortable at a higher cool setting, which saves energy.

Remember to allow some time for the thermostat to adapt to a new setting.

□ REAL TIME PRICING SYSTEM

Your thermostat may be configured to adjust its temperature settings in response to changes in the cost of energy. Using this feature, you can take advantage of your energy provider's rate structure without sacrificing your comfort.

The thermostat can make adjustments for 4 energy rates: LO, MID, HI and CRIT (critical). At LO energy rates, the thermostat controls your system as it normally would, with no variation for energy rates. For each of the higher rates, MID, HI and CRIT, you can easily set the number of degrees of variation by changing the VAR (variation) settings for the rate.

The rate currently in effect is provided to the thermostat by the energy provider's meter or other device. The thermostat will raise the cool setting or lower the heat setting by the amount that you select for the higher rates. The thermostat display will show which rate is in use by periodically flashing RATE - LO, MID, HI or CRIT in the time display.

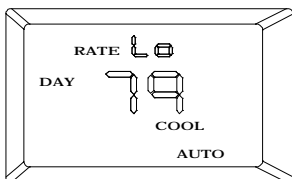

The thermostat remembers your original settings, and will show them if you press the up or down arrows to see the desired settings. The thermostat will control using the original setting and the variation for the rate in use. For example, if your heat setting is 68 degrees, the rate is hi, and the variance for hi is set to 3, the thermostat will control to 65 degrees.

Real time pricing variations can be used with or without the programming feature of the thermostat.

SETTING THE CURRENT TIME AND DAY

To set or change the current time and day, press and release the Prog key. The hour will blink.

1. Use the arrow keys (\wedge - \vee) to change the hour.

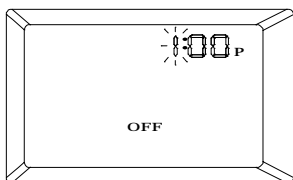

2. Press the Prog key to advance to minutes.
3. Use the arrow keys (\wedge - \vee) to change minutes.

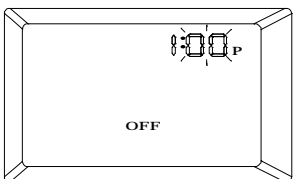

4. Press the Prog key to advance to day of week.
5. Use the arrow keys (\wedge - \vee) to set the day of week (1=Monday - 7=Sunday).

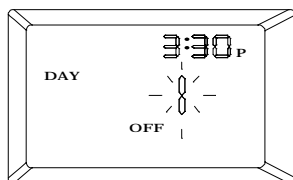

Press the Mode key when complete, or simply wait 8 seconds for the display to return to normal.

□ PROGRAMMING

Your thermostat may be programmed to adjust the heating and cooling settings up to 4 times per day (MORN, DAY, EVE, NITE). You can setup a temperature time schedule for weekdays, Saturday, and Sunday.

To enter programming mode, press the Prog key 4 times.

When in programming mode:

1. The item that is being programmed will flash.
2. The up arrow key (^) is used to increase the value.
3. The down arrow key (v) is used to decrease the value.
4. The Prog (>) key is used to advance to the next item.
5. The Hold (<) key is used to return to the previous item.
6. To exit programming mode, press the Mode key.

The thermostat will automatically exit programming mode after 20 seconds of no key activity.

SETTING THE VARIATION FOR HIGHER RATES

To view or change the variation for MID, HI and CRIT rates, press the Prog key four times. The display will show RATE MID. The variation, in degrees, for the MID rate will flash:

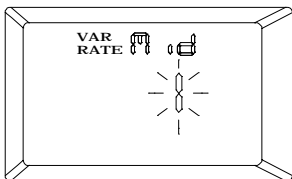

1. Use the arrow keys to change the variance for the MID rate.
2. Press the Prog key to advance to the HI rate. Use the arrow keys to change the variance for the HI rate.
3. Repeat step 2 for the CRIT (critical) rate.

(Typical settings for variance are: MID: 1, HI: 3, CRIT: 6)

SETTING TIME SCHEDULES

When programming a time for the Morning, Day, Evening, or Night period, the time will be increased or decreased in 15 minute increments. If the up arrow is pressed at 11:45 PM, or the down arrow is pressed at 12:00 AM, the time display will be blank, indicating that no scheduled temperature changes will be made for that period.

Your thermostat will follow a set of time scheduled programs on weekdays (Monday-Friday), on Saturday, and on Sunday. This will allow you to have different heating and cooling settings on Saturday and Sunday, than you normally would have for weekdays (Monday - Friday). When programming the time schedules, the weekday time schedule is programmed first. The Saturday time schedule is programmed second, and the Sunday time schedule is programmed last.

To view or change the programming time schedules of your thermostat, press and the Prog key four times. The weekday MORN time will flash.

1. Use the arrow keys (\wedge - \vee) to change the scheduled time for the displayed period (MORN, DAY, EVE, or NITE)

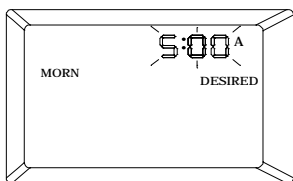

2. Press the Prog key to advance to the next item.
3. Use the arrow keys (\wedge - \vee) to change the desired cool setting.

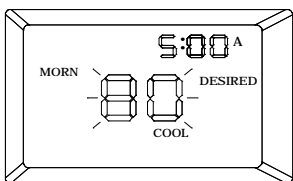

4. Press the Prog key to advance to the next item.
5. Use the arrow keys (\wedge - \vee) to change the desired heat setting.

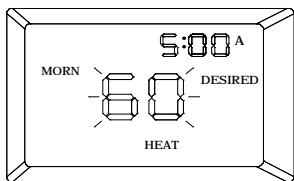

6. Press the Prog key to advance to the next period.

Repeat steps 1-6 for the DAY, EVE, and NITE periods. Afterwards, repeat steps 1-6 for 4 daily periods on Saturdays (Day 6), and 4 daily periods on Sundays (Day 7). The temperature display will show "6" for Saturdays, and "7" for Sunday times.

Note: If *Programming Mode* is not being used and *Day/Night Mode* is being used, only the Weekday - DAY and NITE settings can be programmed.

SYSTEM MODE

Your thermostat can be connected to an automation system or personal computer. With network software, the remote system can send commands to the thermostat to change mode, cool setting, heat setting, status of fan and hold, and other items.

"REMOTE" will be displayed when a command is sent from the automation system or personal computer. You can use the arrow keys (^-v) on the thermostat to change the temperature settings. When the temperature settings are changed at the thermostat, "REMOTE" will no longer be displayed. Press the Hold key to prevent thermostat programs or the remote system from changing temperature settings. "HOLD" will be displayed at the thermostat.

AUTOMATIC TIME UPDATE

The thermostat time will automatically be updated by the connected automation system.

POWER OUTAGES

The thermostat will restart the heating/cooling system 3 to 8 minutes after the electricity comes back on. All settings and programs are stored permanently, and will not be affected by a power outage.

CLOCK

The thermostat clock is maintained for approximately 25 minutes during an electrical outage.

TIME SCHEDULES

The table below shows the time schedules that are currently set into your thermostat. There is a blank table at the bottom that can be used to plan changes to the current schedule.

	WEEKDAYS	SATURDAYS	SUNDAYS
MORN	6:00 AM	8:00 AM	8:00 AM
COOL	78	78	78
HEAT	70	70	70
DAY	8:00 AM		
COOL	85	85	85
HEAT	62	62	62
EVE	6:00 PM		
COOL	78	78	78
HEAT	70	70	70
NITE	10:00 PM	11:00 PM	10:00 PM
COOL	82	82	82
HEAT	62	62	62

	WEEKDAYS	SATURDAYS	SUNDAYS
MORN			
COOL			
HEAT			
DAY			
COOL			
HEAT			
EVE			
COOL			
HEAT			
NITE			

COOL			
HEAT			

TWO YEAR LIMITED WARRANTY

Home Automation, Inc. (HAI), warrants this product against defects in material and workmanship, under normal use and service, for a period of two (2) years from the date of purchase by the consumer.

During the warranty period, HAI will repair or replace, at its option, any HAI thermostat that fails due to defect.

This warranty does not cover the cost of removal or reinstallation of any thermostat. **This warranty does not cover failure caused by damage to the thermostat while in your possession (other than damage caused by defect or malfunction), or by its improper installation, including failure to follow the written installation and operation instructions, alterations, misuse, or abuse.** The remedies provided for in this warranty are the sole and exclusive remedies therefor. In no event shall HAI be liable for incidental expenses or consequential loss or damages.

Any implied warranties, including warranties of merchantability and fitness for particular use or purpose is limited to a period of two (2) years from purchase date.

This warranty gives you specific legal rights, and you may have other legal rights, which vary from state to state. Some limitations may not apply to you.

For warranty and repair service,

Within Continental United States, send defective unit carefully packaged, postage prepaid, along with description of trouble and return address to:

Home Automation, Inc.
Service Department
5725 Powell Street, Suite A
New Orleans, LA 70123

Outside of Continental United States:

Contact an Authorized Distributor for repair/replacement instructions.

For Customer Service or Technical Support
Call us at (504) 736-9810
Monday - Friday, 9:00 a.m. to 5:00 p.m. Central time